

### FEATURES

- Allows safe board insertion and removal from a live backplane
- Controls supply voltages from 3.15 V to 16.5 V
- Precision current sense amplifier
- Precision voltage input
- 12-bit ADC for current and voltage readback
- Charge pumped gate drive for external N-channel FET
- Adjustable analog current limit with circuit breaker
- ±3% accurate hot swap current limit level
- Fast response limits peak fault current
- Automatic retry or latch-off on current fault
- Programmable hot swap timing via TIMER pin
- Soft start pin for reference adjustment and programming of initial current ramp rate
- Active high ON pin
- I<sup>2</sup>C fast mode-compliant interface (400 kHz maximum)
- 10-lead MSOP

### APPLICATIONS

- Power monitoring/power budgeting
- Central office equipment
- Telecommunications and data communications equipment
- PCs/servers

### GENERAL DESCRIPTION

The ADM1177 is an integrated hot swap controller that offers digital current and voltage monitoring via an on-chip, 12-bit analog-to-digital converter (ADC), communicated through an I<sup>2</sup>C® interface.

An internal current sense amplifier measures voltage across the sense resistor in the power path via the VCC pin and the SENSE pin.

The ADM1177 limits the current through this resistor by controlling the gate voltage (via the GATE pin) of an external N-channel FET in the power path. The voltage across the sense resistor (and, therefore, the inrush current) is kept below a preset maximum.

The ADM1177 protects the external FET by limiting the time that the maximum current runs through it. This current limit period is set by the value of the capacitor attached to the TIMER pin. Additionally, the device provides protection from overcurrent events that may occur once the hot swap event is complete. In the case of a short-circuit event, the current in the sense resistor exceeds an overcurrent trip threshold, and the FET is switched off immediately by pulling down the GATE pin.

#### Rev. B

Information furnished by Analog Devices is believed to be accurate and reliable. However, no responsibility is assumed by Analog Devices for its use, nor for any infringements of patents or other rights of third parties that may result from its use. Specifications subject to change without notice. No license is granted by implication or otherwise under any patent or patent rights of Analog Devices. Trademarks and registered trademarks are the property of their respective owners.

### FUNCTIONAL BLOCK DIAGRAM

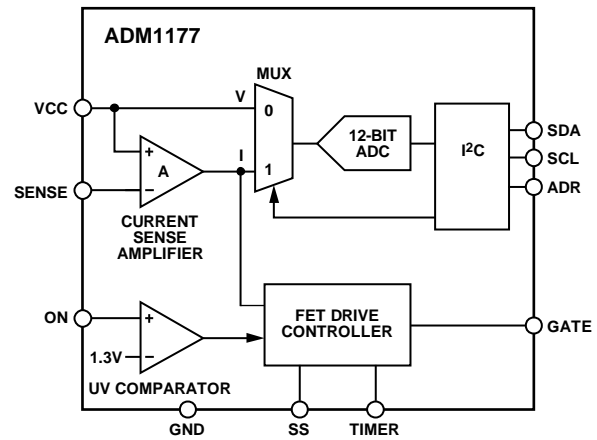

Figure 1.

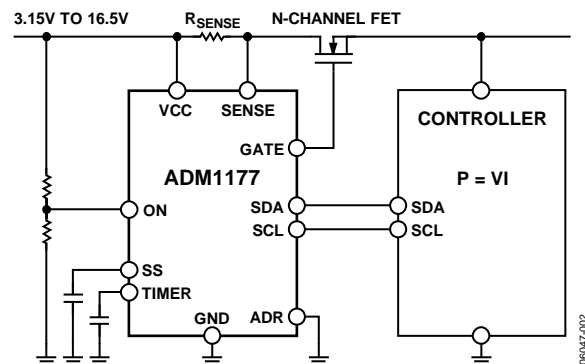

Figure 2. Applications Diagram

A soft start pin (SS) is also included. This gives the user control over the reference on the current sense amplifier. An internal current source charges a capacitor on this pin at startup, allowing the user to set the profile of the initial current ramp. A voltage can also be driven on this pin to alter the reference.

A 12-bit ADC can measure the current seen in the sense resistor, as well as the supply voltage on the VCC pin. An industry-standard I<sup>2</sup>C interface allows a controller to read current and voltage data from the ADC. Measurements can be initiated by an I<sup>2</sup>C command. Alternatively, the ADC can run continuously, and the user can read the latest conversion data whenever it is required. Up to four unique I<sup>2</sup>C addresses can be created, depending on how the ADR pin is connected.

The ADM1177 is packaged in a 10-lead MSOP.

## TABLE OF CONTENTS

|   |    |  |    |
|---|----|--|----|
| Features .....  | 1  | Initial Timing Cycle .....                               | 13 |
| Applications.....   | 1  | Hot Swap Retry Cycle on the ADM1177-1.....               | 14 |
| General Description .....                                 | 1  | Soft Start (SS Pin) .....                                | 14 |
| Functional Block Diagram .....                            | 1  | Voltage and Current Readback.....                        | 15 |
| Revision History .....                                    | 2  | Serial Bus Interface.....                                | 15 |
| Specifications.....                                       | 3  | Identifying the ADM1177 on the I <sup>2</sup> C Bus..... | 15 |
| Absolute Maximum Ratings.....                             | 5  | General I <sup>2</sup> C Timing.....                     | 15 |
| Thermal Characteristics .....                             | 5  | Write and Read Operations.....                           | 17 |
| ESD Caution.....  | 5  | Quick Command.....                                       | 17 |
| Pin Configuration and Function Descriptions.....          | 6  | Write Command Byte.....                                  | 17 |
| Typical Performance Characteristics .....                 | 7  | Write Extended Command Byte .....                        | 18 |
| Overview of the Hot Swap Function.....                    | 12 | Read Voltage and/or Current Data Bytes.....              | 19 |
| Undervoltage Lockout .....                                | 12 | Applications Information .....                           | 21 |
| ON Function .....   | 12 | Applications Waveforms.....                              | 21 |
| TIMER Function .....                                      | 12 | Kelvin Sense Resistor Connection .....                   | 22 |
| GATE and TIMER Functions During a Hot Swap                |    | Outline Dimensions .....                                 | 23 |
| Operation.....  | 13 | Ordering Guide .....                                     | 23 |
| Calculating Current Limits and Fault Current Limit Time.. | 13 |  |    |

## REVISION HISTORY

### 2/08—Rev. A to Rev. B

|   |    |
|---|----|
| Changed V <sub>VCC</sub> to V <sub>CC</sub> Throughout .....                | 3  |
| Changes to Input Current for 00 Decode, I <sub>ADRLOW</sub> Parameter.....  | 3  |
| Changes to Input Current for 11 Decode, I <sub>ADRHIGH</sub> Parameter..... | 3  |
| Added ADC Conversion Time Parameter .....                                   | 4  |
| Added Fast Overcurrent Response Time Parameter .....                        | 4  |
| Added Endnote 2 and Endnote 3 .....   | 4  |
| Changes to Figure 14.....   | 8  |
| Changes to Figure 15 Caption.....   | 8  |
| Changes to Figure 24.....   | 10 |
| Changes to TIMER Function Section .....                                     | 12 |
| Changes to Table 5.....   | 15 |
| Changes to General I <sup>2</sup> C Timing Section.....                     | 15 |
| Changes to Quick Command Section .....                                      | 17 |
| Changes to Figure 35.....   | 17 |
| Changes to Table 7.....   | 17 |
| Changes to Write Extended Command Byte Section.....                         | 18 |
| Changes to Figure 39.....   | 18 |
| Changes to Table 9 and Table 11.....  | 18 |
| Changes to Converting ADC Codes to Voltage and                              |    |
| Current Readings Section.....   | 19 |

### 4/07—Rev. 0 to Rev. A

|   |    |
|---|----|
| Changes to GATE and TIMER Functions During              |    |
| a Hot Swap Section.....                                 | 14 |
| Changes to Calculating Current Limits and Fault Current |    |
| Limit Time Section.....                                 | 14 |
| Changes to Initial Timing Cycle Section.....            | 14 |
| Changes to Soft Start (SS Pin) Section .....            | 15 |
| Changes to Table 5.....                                 | 16 |
| Changes to Figure 34 and Figure 35.....                 | 17 |
| Changes to Figure 39.....                               | 19 |
| Changes to Figure 41 and Figure 42.....                 | 20 |
| Added Applications Information Heading .....            | 22 |

### 9/06—Revision 0: Initial Version

## SPECIFICATIONS

$V_{CC} = 3.15\text{ V to }16.5\text{ V}$ ;  $T_A = -40^\circ\text{C to }+85^\circ\text{C}$ ; typical values at  $T_A = 25^\circ\text{C}$ , unless otherwise noted.

**Table 1.**

| Parameter  | Min   | Typ  | Max   | Unit          | Conditions   |
|--|-------|------|-------|---------------|--|
| <b>VCC PIN</b>                                     |       |      |       |               |  |
| Operating Voltage Range, $V_{CC}$                  | 3.15  |      | 16.5  | V             |  |
| Supply Current, $I_{CC}$                           |       | 1.7  | 2.5   | mA            |  |
| Undervoltage Lockout, $V_{UVLO}$                   |       | 2.8  |       | V             | $V_{CC}$ rising  |
| Undervoltage Lockout Hysteresis, $V_{UVLOHYS}$     |       | 80   |       | mV            |  |
| <b>ON PIN</b>                                      |       |      |       |               |  |
| Input Current, $I_{INON}$                          | -100  |      | +100  | nA            | ON < 1.5 V   |
|  | -2    |      | +2    | $\mu\text{A}$ |  |
| Rising Threshold, $V_{ONTH}$                       | 1.26  | 1.3  | 1.34  | V             | ON rising  |
| Trip Threshold Hysteresis, $V_{ONHYS}$             | 35    | 50   | 65    | mV            |  |
| Glitch Filter Time                                 |       | 3    |       | $\mu\text{s}$ |  |
| <b>SS PIN</b>                                      |       |      |       |               |  |
| Pull-Up Current, $I_{SSPU}$                        |       | 10   |       | $\mu\text{A}$ | $V_{SS} = 0\text{ V to }1\text{ V}$  |
| Current Setting Gain, $GAIN_{SS}$                  | 9.5   | 10   | 10.5  | V/V           | $V_{SS}/V_{CB}$ ; $V_{SS} = 0.5\text{ V to }1\text{ V}$                                      |
| Soft Start Completion Voltage, $SS_{HIGHV}$        |       | 1    |       | V             | SS continues to pull up beyond 1 V   |
| Pull-Down Current, $I_{SSPD}$                      |       | 70   |       | $\mu\text{A}$ | Under fault  |
| <b>SENSE PIN</b>                                   |       |      |       |               |  |
| Input Leakage, $I_{SENSE}$                         | -1    |      | +1    | $\mu\text{A}$ | $V_{SENSE} = V_{CC}$   |
| Overcurrent Fault Timing Threshold, $V_{OCTRIM}$   | 92    |      |       | mV            | $V_{OCTRIM} = (V_{CC} - V_{SENSE})$ , fault timing starts on the TIMER pin                   |
| Overcurrent Limit Threshold, $V_{LIM}$             | 97    | 100  | 103   | mV            | $V_{LIM} = (V_{CC} - V_{SENSE})$ , closed-loop regulation to a current limit                 |
| Fast Overcurrent Trip Threshold, $V_{OCFAST}$      |       |      | 115   | mV            | $V_{OCFAST} = (V_{CC} - V_{SENSE})$ , gate pull-down current turned on                       |
| <b>GATE PIN</b>                                    |       |      |       |               |  |
| Drive Voltage, $V_{GATE}$                          | 3     | 6    | 9     | V             | $V_{GATE} - V_{CC}$ , $V_{CC} = 3.15\text{ V}$   |
|  | 9     | 11   | 13    | V             | $V_{GATE} - V_{CC}$ , $V_{CC} = 5\text{ V}$  |
|  | 7     | 10   | 13    | V             | $V_{GATE} - V_{CC}$ , $V_{CC} = 16.5\text{ V}$   |
| Pull-Up Current                                    | 8     | 12.5 | 17    | $\mu\text{A}$ | $V_{GATE} = 0\text{ V}$  |
| Pull-Down Current                                  |       | 1.5  |       | mA            | $V_{GATE} = 3\text{ V}$ , $V_{CC} = 3.15\text{ V}$   |
|  |       | 5    |       | mA            | $V_{GATE} = 3\text{ V}$ , $V_{CC} = 5\text{ V}$  |
|  |       | 7    |       | mA            | $V_{GATE} = 3\text{ V}$ , $V_{CC} = 16.5\text{ V}$   |
| <b>TIMER PIN</b>                                   |       |      |       |               |  |
| Pull-Up Current (Power-On Reset), $I_{TIMERUPPOR}$ | -3.5  | -5   | -6.5  | $\mu\text{A}$ | Initial cycle, $V_{TIMER} = 1\text{ V}$  |
| Pull-Up Current (Fault Mode), $I_{TIMERUPFAULT}$   | -40   | -60  | -80   | $\mu\text{A}$ | During current fault, $V_{TIMER} = 1\text{ V}$   |
| Pull-Down Current (Retry Mode), $I_{TIMERDNRETRY}$ |       | 2    | 3     | $\mu\text{A}$ | After current fault and during a cooldown period on a retry device, $V_{TIMER} = 1\text{ V}$ |
| Pull-Down Current, $I_{TIMERDN}$                   |       | 100  |       | $\mu\text{A}$ | Normal operation, $V_{TIMER} = 1\text{ V}$   |
| Trip Threshold High, $V_{TIMERH}$                  | 1.26  | 1.3  | 1.34  | V             | TIMER rising   |
| Trip Threshold Low, $V_{TIMERL}$                   | 0.175 | 0.2  | 0.225 | V             | TIMER falling  |
| <b>ADR PIN</b>                                     |       |      |       |               |  |
| Set Address to 00, $V_{ADRL0V}$                    | 0     |      | 0.8   | V             | Low state  |
| Set Address to 01, $R_{ADRL0V}$                    | 135   | 150  | 165   | k $\Omega$    | Resistor to ground state, load pin with specified resistance for 01 decode                   |
| Set Address to 10, $I_{ADRHIGHZ}$                  | -1    |      | +1    | $\mu\text{A}$ | Open state, maximum load allowed on the ADR pin for 10 decode                                |
| Set Address to 11, $V_{ADRHIGHV}$                  | 2     |      | 5.5   | V             | High state   |
| Input Current for 00 Decode, $I_{ADRLOW}$          | -40   | -22  |       | $\mu\text{A}$ | $V_{ADR} = 0\text{ V to }0.8\text{ V}$   |
| Input Current for 11 Decode, $I_{ADRHIGH}$         |       | 3    | 10    | $\mu\text{A}$ | $V_{ADR} = 2.0\text{ V to }5.5\text{ V}$   |

# ADM1177

| Parameter  | Min                       | Typ    | Max                  | Unit | Conditions   |
|--|---------------------------|--------|----------------------|------|--|
| <b>MONITORING ACCURACY<sup>1</sup></b>   |                           |        |                      |      |  |
| Current Sense Absolute Accuracy  |                           |        |                      |      |  |
| 0°C to +70°C   | -1.45                     |        | +1.45                | %    | V <sub>SENSE</sub> = 75 mV                         |
|  | -1.8                      |        | +1.8                 | %    | V <sub>SENSE</sub> = 50 mV                         |
|  | -2.8                      |        | +2.8                 | %    | V <sub>SENSE</sub> = 25 mV                         |
|  | -5.7                      |        | +5.7                 | %    | V <sub>SENSE</sub> = 12.5 mV                       |
| 0°C to +85°C   | -1.5                      |        | +1.5                 | %    | V <sub>SENSE</sub> = 75 mV                         |
|  | -1.8                      |        | +1.8                 | %    | V <sub>SENSE</sub> = 50 mV                         |
|  | -2.95                     |        | +2.95                | %    | V <sub>SENSE</sub> = 25 mV                         |
|  | -6.1                      |        | +6.1                 | %    | V <sub>SENSE</sub> = 12.5 mV                       |
| -40°C to +85°C   | -1.95                     |        | +1.95                | %    | V <sub>SENSE</sub> = 75 mV                         |
|  | -2.45                     |        | +2.45                | %    | V <sub>SENSE</sub> = 50 mV                         |
|  | -3.85                     |        | +3.85                | %    | V <sub>SENSE</sub> = 25 mV                         |
|  | -6.7                      |        | +6.7                 | %    | V <sub>SENSE</sub> = 12.5 mV                       |
| V <sub>SENSE</sub> for ADC Full Scale <sup>2</sup>                             |                           | 105.84 |                      | mV   |  |
| Voltage Sense Accuracy   |                           |        |                      |      |  |
| 0°C to +70°C   | -0.85                     |        | +0.85                | %    | V <sub>CC</sub> = 3 V minimum (low range)          |
|  | -0.9                      |        | +0.9                 | %    | V <sub>CC</sub> = 6 V minimum (high range)         |
| 0°C to +85°C   | -0.85                     |        | +0.85                | %    | V <sub>CC</sub> = 3 V minimum (low range)          |
|  | -0.9                      |        | +0.9                 | %    | V <sub>CC</sub> = 6 V minimum (high range)         |
| -40°C to +85°C   | -0.9                      |        | +0.9                 | %    | V <sub>CC</sub> = 3 V minimum (low range)          |
|  | -1.15                     |        | +1.15                | %    | V <sub>CC</sub> = 6 V minimum (high range)         |
| V <sub>CC</sub> for ADC Full Scale <sup>3</sup>                                |                           |        |                      |      |  |
| Low Range (VRANGE = 1)   |                           | 6.65   |                      | V    |  |
| High Range (VRANGE = 0)  |                           | 26.35  |                      | V    |  |
| <b>I<sup>2</sup>C TIMING</b>   |                           |        |                      |      |  |
| Low Level Input Voltage, V <sub>IL</sub>                                       |                           |        | 0.3 V <sub>BUS</sub> | V    |  |
| High Level Input Voltage, V <sub>IH</sub>                                      | 0.7 V <sub>BUS</sub>      |        |                      | V    |  |
| Low Level Output Voltage on SDA, V <sub>OL</sub>                               |                           |        | 0.4                  | V    | I <sub>OL</sub> = 3 mA                             |
| Output Fall Time on SDA from V <sub>IHMIN</sub> to V <sub>ILMAX</sub>          | 20 + 0.1 C <sub>BUS</sub> |        | 250                  | ns   | C <sub>BUS</sub> = bus capacitance from SDA to GND |
| Maximum Width of Spikes Suppressed by Input Filtering on SDA and SCL Pins      | 50                        |        | 250                  | ns   |  |
| Input Current, I <sub>I</sub> , on SDA/SCL When Not Driving a Logic Low Output | -10                       |        | +10                  | μA   |  |
| Input Capacitance on SDA/SCL   |                           | 5      |                      | pF   |  |
| SCL Clock Frequency, f <sub>SCL</sub>  |                           |        | 400                  | kHz  |  |
| Low Period of the SCL Clock  | 600                       |        |                      | ns   |  |
| High Period of the SCL Clock   | 1300                      |        |                      | ns   |  |
| Setup Time for a Repeated Start Condition, t <sub>SU,STA</sub>                 | 600                       |        |                      | ns   |  |
| SDA Output Data Hold Time, t <sub>HD,DAT</sub>                                 | 100                       |        | 900                  | ns   |  |
| ADC Conversion Time <sup>4</sup>   |                           | 150    |                      | μs   |  |
| Fast Overcurrent Response Time <sup>5</sup>                                    |                           | 4      | 10                   | μs   |  |
| Setup Time for a Stop Condition, t <sub>SU,STO</sub>                           | 600                       |        |                      | ns   |  |
| Bus Free Time Between a Stop and a Start Condition, t <sub>BUF</sub>           | 1300                      |        |                      | ns   |  |
| Capacitive Load for Each Bus Line  |                           |        | 400                  | pF   |  |

<sup>1</sup> Monitoring accuracy is a measure of the error in a code that is read back for a particular voltage/current. This is a combination of amplifier error, reference error, ADC error, and error in ADC full-scale code conversion factor.

<sup>2</sup> This is an absolute value to be used when converting ADC codes to current readings; any inaccuracy in this value is factored into absolute current accuracy values (see specifications for Current Sense Absolute Accuracy).

<sup>3</sup> These are absolute values to be used when converting ADC codes to voltage readings; any inaccuracy in these values are factored into voltage accuracy values (see specifications for Voltage Sense Accuracy).

<sup>4</sup> Time between the receipt of the command byte and the actual ADC result being placed in the register.

<sup>5</sup> Guaranteed by design; not production tested.

## ABSOLUTE MAXIMUM RATINGS

Table 2.

| Parameter                            | Rating          |
|--------------------------------------|-----------------|
| VCC Pin                              | 20 V            |
| SENSE Pin                            | 20 V            |
| TIMER Pin                            | -0.3 V to +6 V  |
| ON Pin                               | -0.3 V to +20 V |
| SS Pin                               | -0.3 V to +6 V  |
| GATE Pin                             | 30 V            |
| SDA Pin, SCL Pin                     | -0.3 V to +7 V  |
| ADR Pin                              | -0.3 V to +6 V  |
| Storage Temperature Range            | -65°C to +125°C |
| Operating Temperature Range          | -40°C to +85°C  |
| Lead Temperature (Soldering, 10 sec) | 300°C           |
| Junction Temperature                 | 150°C           |

Stresses above those listed under Absolute Maximum Ratings may cause permanent damage to the device. This is a stress rating only; functional operation of the device at these or any other conditions above those indicated in the operational section of this specification is not implied. Exposure to absolute maximum rating conditions for extended periods may affect device reliability.

## THERMAL CHARACTERISTICS

$\theta_{JA}$  is specified for the worst-case conditions, that is, a device soldered in a circuit board for surface-mount packages.

Table 3. Thermal Resistance

| Package Type | $\theta_{JA}$ | Unit |
|--------------|---------------|------|
| 10-Lead MSOP | 137.5         | °C/W |

## ESD CAUTION



**ESD (electrostatic discharge) sensitive device.** Charged devices and circuit boards can discharge without detection. Although this product features patented or proprietary protection circuitry, damage may occur on devices subjected to high energy ESD. Therefore, proper ESD precautions should be taken to avoid performance degradation or loss of functionality.

## PIN CONFIGURATION AND FUNCTION DESCRIPTIONS

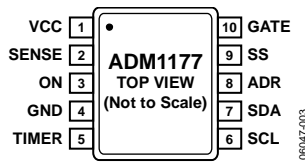

Figure 3. Pin Configuration

Table 4. Pin Function Descriptions

| Pin No. | Mnemonic | Description  |
|---------|----------|--|
| 1       | VCC      | Positive Supply Input Pin. The operating supply voltage range is from 3.15 V to 16.5 V. An undervoltage lockout (UVLO) circuit resets the ADM1177 when a low supply voltage is detected.   |
| 2       | SENSE    | Current Sense Input Pin. A sense resistor between the VCC pin and the SENSE pin sets the analog current limit. The hot swap operation of the ADM1177 controls the external FET gate to maintain the $(V_{CC} - V_{SENSE})$ voltage at or below 100 mV.   |
| 3       | ON       | Undervoltage Input Pin. Active high pin. An internal undervoltage comparator has a trip threshold of 1.3 V, and the output of this comparator is used as an enable for the hot swap operation. With an external resistor divider from VCC to GND, the ON pin can be used to enable the hot swap operation for a specific voltage on VCC, providing an undervoltage function. |
| 4       | GND      | Chip Ground Pin.   |
| 5       | TIMER    | Timer Pin. An external capacitor, $C_{TIMER}$ , sets a 270 ms/ $\mu$ F initial timing cycle delay and a 21.7 ms/ $\mu$ F fault delay. The GATE pin turns off when the TIMER pin is pulled beyond the upper threshold. An overvoltage detection with an external Zener can be used to force this pin high.  |
| 6       | SCL      | I <sup>2</sup> C Clock Pin. Open-drain input requires an external resistive pull-up.   |
| 7       | SDA      | I <sup>2</sup> C Data I/O Pin. Open-drain input/output. Requires an external resistive pull-up.  |
| 8       | ADR      | I <sup>2</sup> C Address Pin. This pin can be tied low, tied high, left floating, or tied low through a resistor to set four different I <sup>2</sup> C addresses.   |
| 9       | SS       | Soft Start Pin. This pin controls the reference on the current sense amplifier. A 10 $\mu$ A current source charges this pin at startup. A capacitor on this pin then sets the slope of the initial current ramp. This pin can also be driven to a voltage to alter the reference directly, thereby adjusting the current limit level with a gain of 10.                     |
| 10      | GATE     | GATE Output Pin. This pin is the high-side gate drive of an external N-channel FET. This pin is driven by the FET drive controller, which utilizes a charge pump to provide a 12.5 $\mu$ A pull-up current to charge the FET GATE pin. The FET drive controller regulates to a maximum load current (100 mV through the sense resistor) by modulating the GATE pin.          |

## TYPICAL PERFORMANCE CHARACTERISTICS

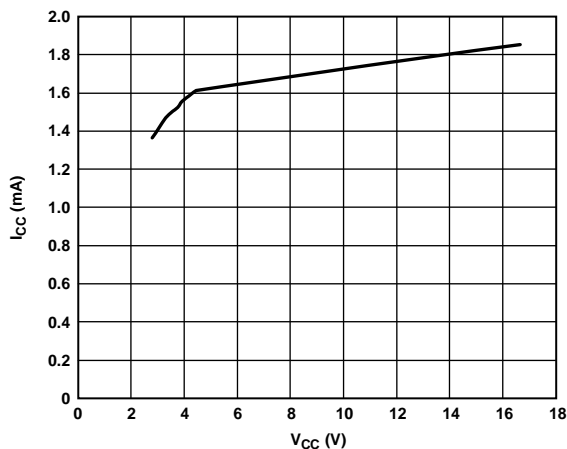

Figure 4. Supply Current vs. Supply Voltage

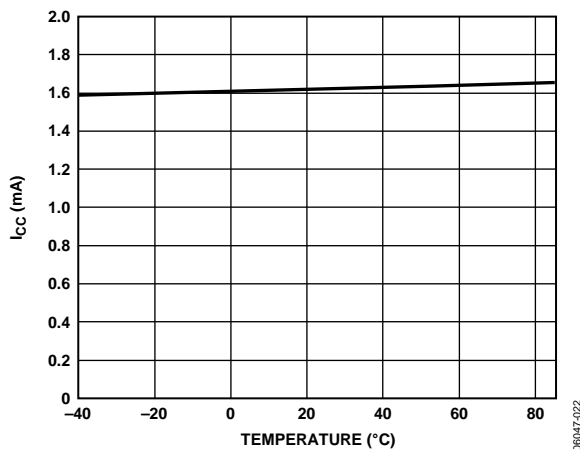

Figure 7. Supply Current vs. Temperature (Gate On)

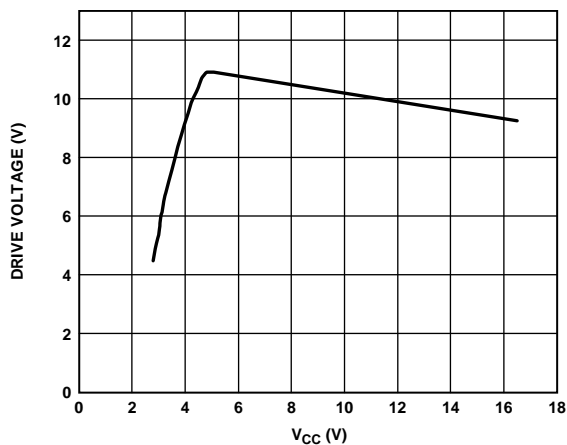

Figure 5. Drive Voltage ( $V_{GATE} - V_{CC}$ ) vs. Supply Voltage

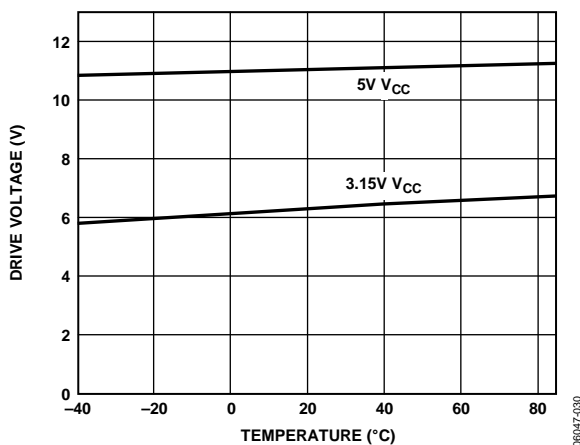

Figure 8. Drive Voltage ( $V_{GATE} - V_{CC}$ ) vs. Temperature

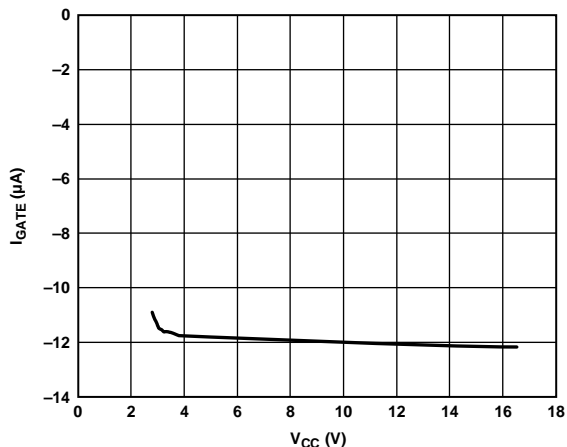

Figure 6. Gate Pull-Up Current vs. Supply Voltage

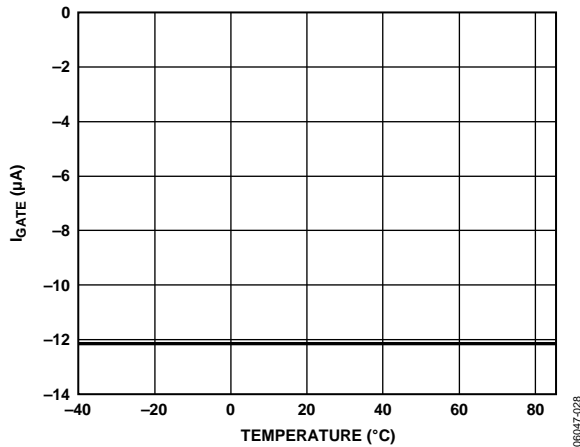

Figure 9. Gate Pull-Up Current vs. Temperature

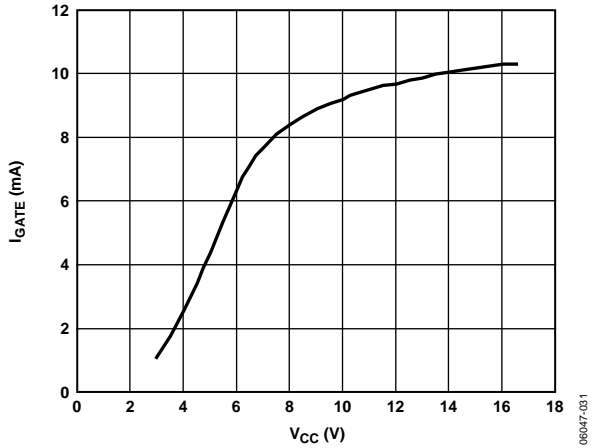

Figure 10. Gate Pull-Down Current vs. Supply Voltage at  $V_{GATE} = 5V$

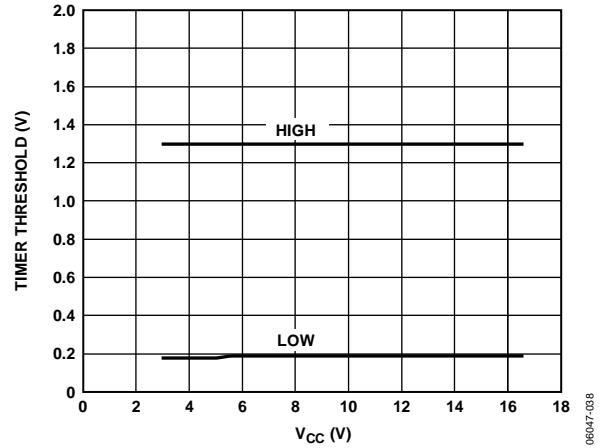

Figure 13. Timer Threshold vs. Supply Voltage

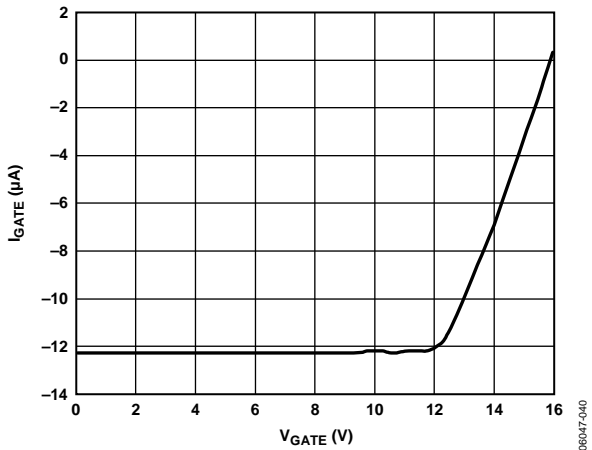

Figure 11. Gate Pull-Up Current vs. Gate Voltage at  $V_{CC} = 5V$

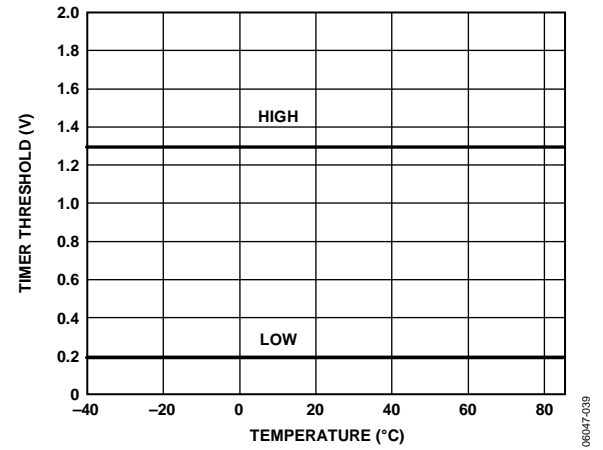

Figure 14. Timer Threshold vs. Temperature

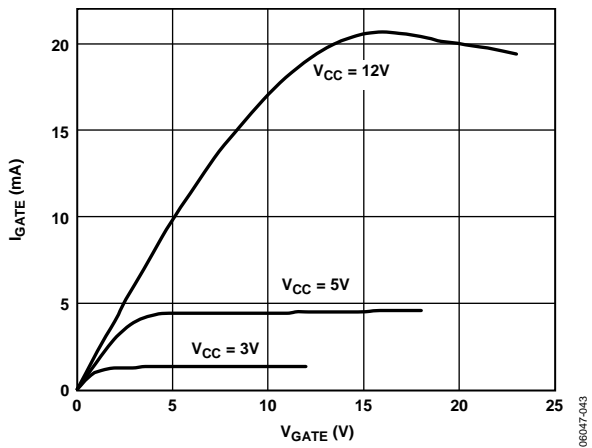

Figure 12. Gate Pull-Down Current vs. Gate Voltage

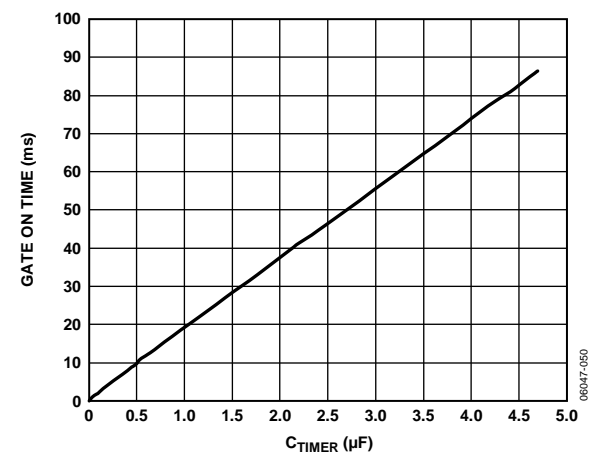

Figure 15. Gate On Time vs. Timer Capacitance During Current Limiting Condition



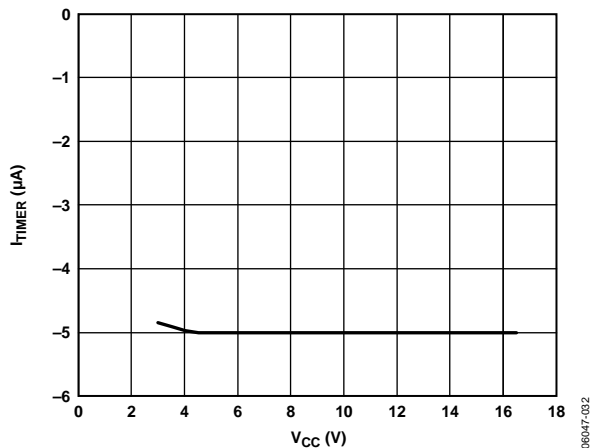

Figure 16. Timer Pull-Up Current (Initial Cycle) vs. Supply Voltage

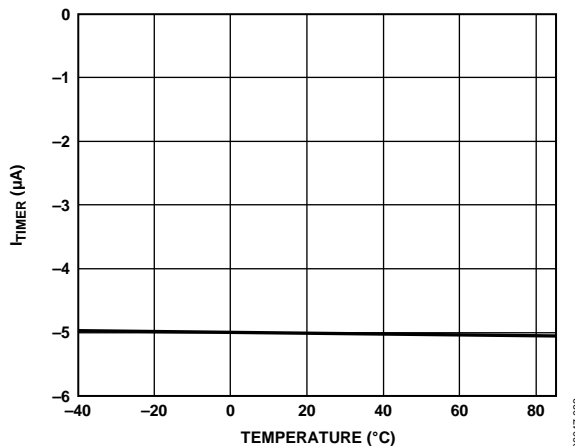

Figure 19. Timer Pull-Up Current (Initial Cycle) vs. Temperature

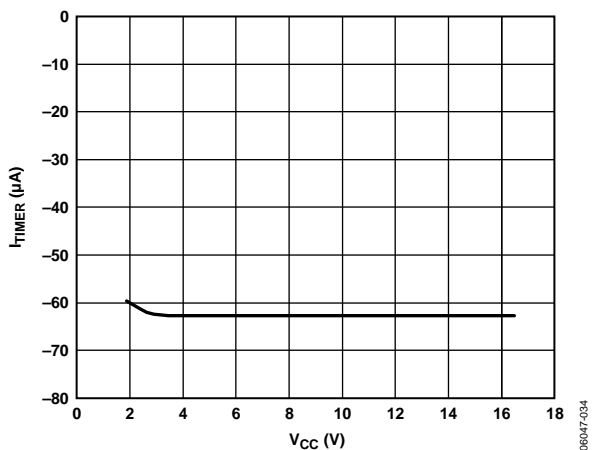

Figure 17. Timer Pull-Up Current (Circuit Breaker Delay) vs. Supply Voltage

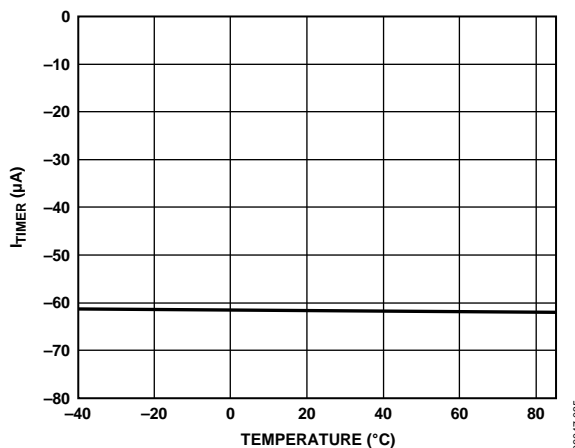

Figure 20. Timer Pull-Up Current (Circuit Breaker Delay) vs. Temperature

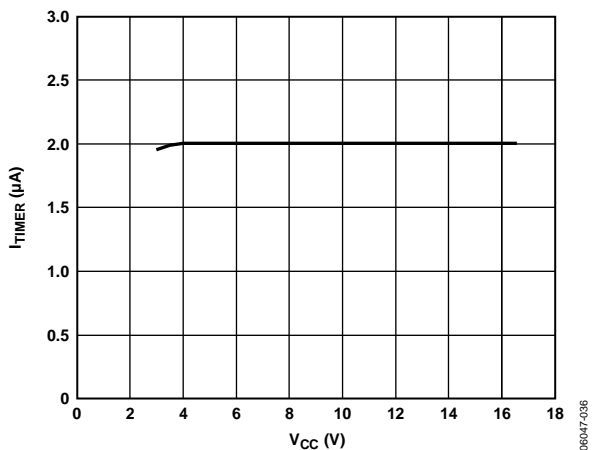

Figure 18. Timer Pull-Down Current (Cooldown/FET Off Cycle) vs. Supply Voltage

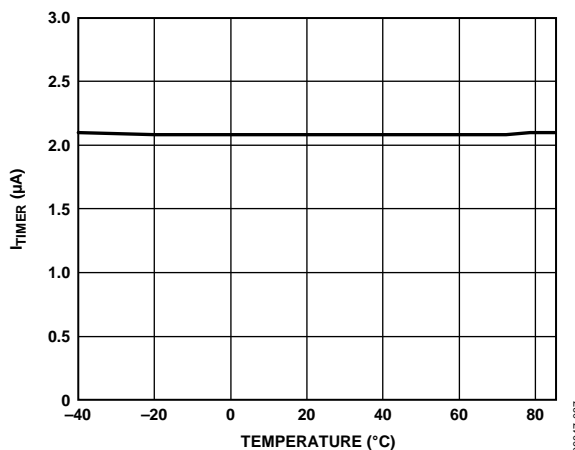

Figure 21. Timer Pull-Down Current (Cooldown/FET Off Cycle) vs. Temperature

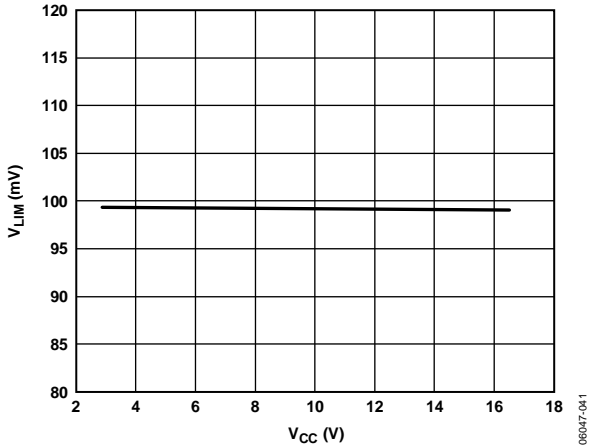

Figure 22. Circuit Breaker Limit Voltage vs. Supply Voltage

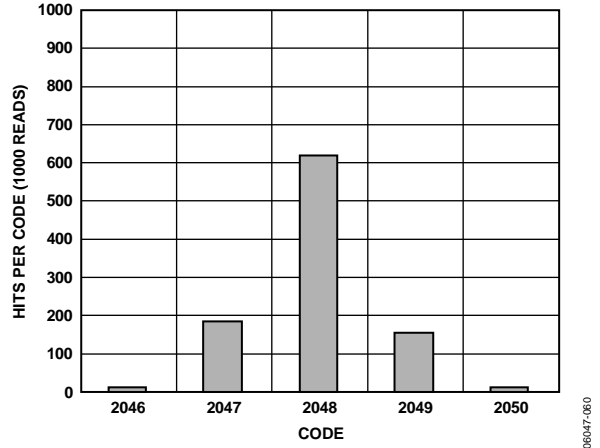

Figure 25. ADC Noise with Current Channel, Midcode Input, and 1000 Reads

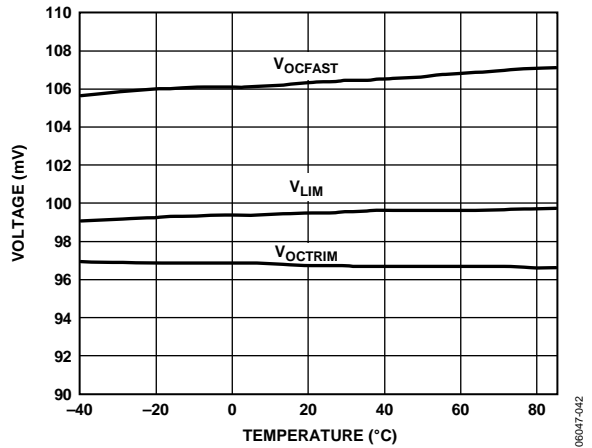

Figure 23. V<sub>OCTRIM</sub>, V<sub>LIM</sub>, V<sub>OFAST</sub> vs. Temperature

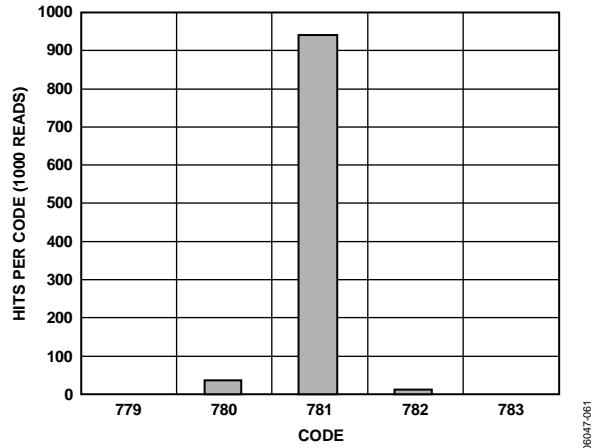

Figure 26. ADC Noise with 14:1 Voltage Channel, 5 V Input, and 1000 Reads

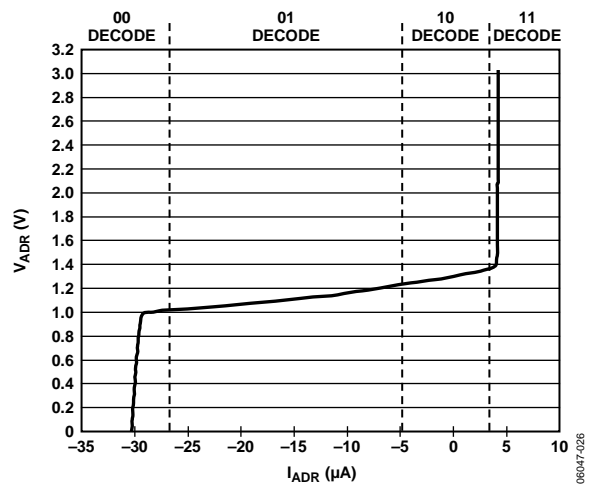

Figure 24. Address Pin Voltage vs. Address Pin Current for Four Addressing Options

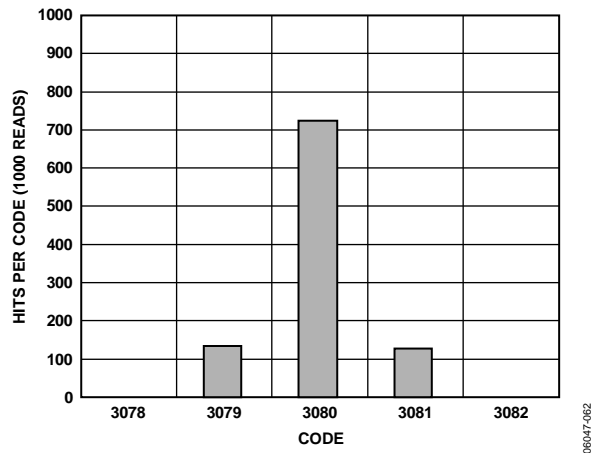

Figure 27. ADC Noise with 7:1 Voltage Channel, 5 V Input, and 1000 Reads

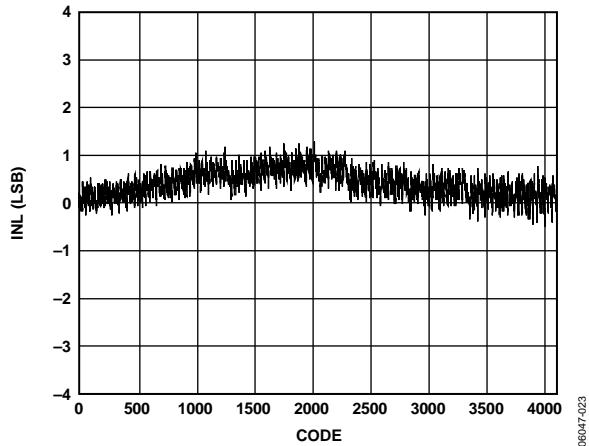

Figure 28. INL for ADC

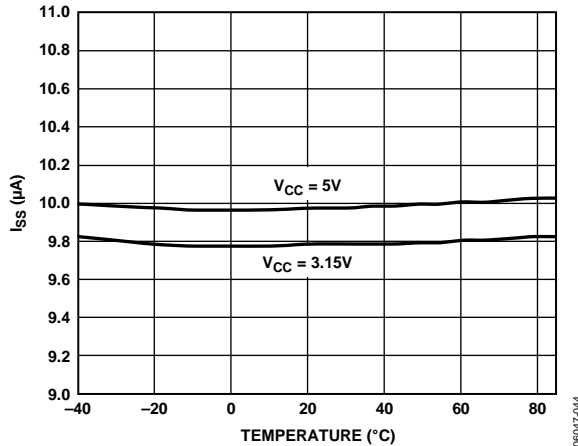

Figure 30. SS Pin Pull-Up Current vs. Temperature

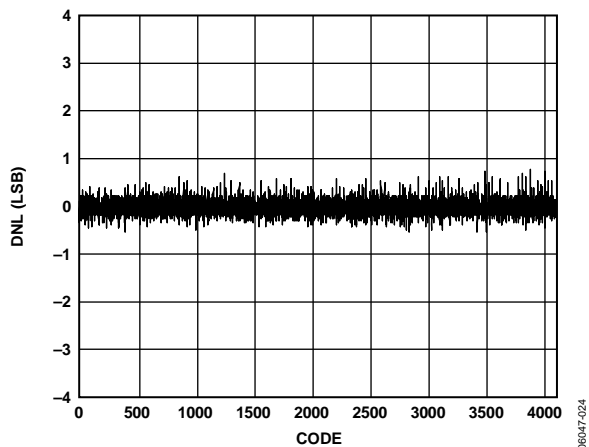

Figure 29. DNL for ADC

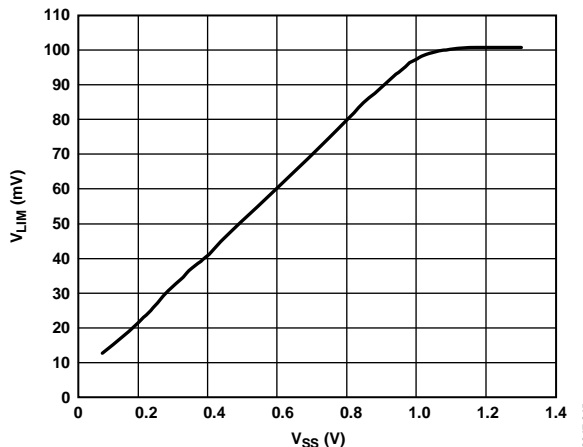

Figure 31. Overcurrent Limit Threshold vs. SS Pin Voltage

## OVERVIEW OF THE HOT SWAP FUNCTION

When circuit boards are inserted into a live backplane, discharged supply bypass capacitors draw large transient currents from the backplane power bus as they charge. Such transient currents can cause permanent damage to connector pins, as well as dips on the backplane supply that can reset other boards in the system. The ADM1177 is designed to turn a circuit board supply voltage on and off in a controlled manner, allowing the circuit board to be safely inserted into or removed from a live backplane. The ADM1177 can reside either on the backplane or on the circuit board itself.

The ADM1177 controls the inrush current to a fixed maximum level by modulating the gate of an external N-channel FET placed between the live supply rail and the load. This hot swap function protects the card connectors and the FET itself from damage and limits any problems that can be caused by the high current loads on the live supply rail.

The ADM1177 holds the GATE pin down (and therefore holds off the FET) until certain conditions are met. An undervoltage lockout circuit ensures that the device is provided with an adequate input supply voltage. After the input supply voltage is successfully detected, the device goes through an initial timing cycle to provide a delay before it attempts a hot swap. This delay ensures that the board is fully seated in the backplane before the board is powered up.

After the initial timing cycle is complete, the hot swap function is switched on under control of the ON pin. When the ON pin is asserted high, the hot swap operation starts.

The ADM1177 charges up the gate of the FET to turn on the load. It continues to charge up the GATE pin until the linear current limit (set to  $100 \text{ mV}/R_{\text{SENSE}}$ ) is reached. For some combinations of low load capacitance and high current limit, this limit may not be reached before the load is fully charged up. If the current limit is reached, the ADM1177 regulates the GATE pin to keep the current at this limit. For currents above the overcurrent fault timing threshold, nominally  $100 \text{ mV}/R_{\text{SENSE}}$ , the current fault is timed by sourcing a current out to the TIMER pin. If the load becomes fully charged before the fault current limit time is reached (when the TIMER pin reaches 1.3 V), the current drops below the overcurrent fault timing threshold. The ADM1177 then charges the GATE pin higher to fully enhance the FET for lowest  $R_{\text{ON}}$ , and the TIMER pin is pulled down again.

If the fault current limit time is reached before the load drops below the current limit, a fault has been detected, and the hot swap operation is aborted by pulling down the GATE pin to turn off the FET.

The ADM1177-2 latches off at this point and attempts to hot swap again only when the ON pin is deasserted and then asserted again. The ADM1177-1 retries the hot swap operation indefinitely, keeping the FET in its safe operating area (SOA) by using the TIMER pin to time a cooldown period between hot swap attempts. The current and voltage threshold combinations on the TIMER pin set the retry duty cycle to 3.8%.

The ADM1177 is designed to operate over a range of supplies from 3.15 V to 16.5 V.

## UNDERVOLTAGE LOCKOUT

An internal undervoltage lockout (UVLO) circuit resets the ADM1177 if the voltage on the VCC pin is too low for normal operation. The UVLO has a low-to-high threshold of 2.8 V, with 80 mV hysteresis. Above 2.8 V supply voltage, the ADM1177 starts the initial timing cycle.

## ON FUNCTION

The ADM1177-1 has an active high ON pin. The ON pin is the input to a comparator that has a low-to-high threshold of 1.3 V, a 50 mV hysteresis, and a glitch filter of 3  $\mu\text{s}$ . A low input on the ON pin turns off the hot swap operation by pulling the GATE pin to ground, turning off the external FET. The TIMER pin is also reset by turning on a pull-down current on this pin. A low-to-high transition on the ON pin starts the hot swap operation. A 10 k $\Omega$  pull-up resistor connecting the ON pin to the supply is recommended.

Alternatively, an external resistor divider at the ON pin can be used to program an undervoltage lockout value that is higher than the internal UVLO circuit, thereby setting the hot swap operation to start on specific voltage level on the VCC pin. An RC filter can be added at the ON pin to increase the delay time at card insertion if the initial timing cycle delay is insufficient.

## TIMER FUNCTION

The TIMER pin handles several timing functions with an external capacitor,  $C_{\text{TIMER}}$ . There are two comparator thresholds:  $V_{\text{TIMERH}}$  (1.3 V) and  $V_{\text{TIMERL}}$  (0.2 V). The four timing current sources are a 5  $\mu\text{A}$  pull-up, a 60  $\mu\text{A}$  pull-up, a 2  $\mu\text{A}$  pull-down, and a 100  $\mu\text{A}$  pull-down. The 100  $\mu\text{A}$  pull-down is a nonideal current source, approximating a 7 k $\Omega$  resistor below 0.4 V.

These current and voltage levels, together with the value of  $C_{\text{TIMER}}$  chosen by the user, determine the initial timing cycle time, the fault current limit time, and the hot swap retry duty cycle.

## GATE AND TIMER FUNCTIONS DURING A HOT SWAP OPERATION

During hot insertion of a board onto a live supply rail at VCC, the abrupt application of supply voltage charges the external FET drain/gate capacitance, which can cause an unwanted gate voltage spike. An internal circuit holds GATE low before the internal circuitry wakes up. This substantially reduces the FET current surges at insertion. The GATE pin is also held low during the initial timing cycle until the ON pin is taken high to start the hot swap operation.

During a hot swap operation, the GATE pin is first pulled up by a 12.5  $\mu\text{A}$  current source. If the current through the sense resistor reaches the overcurrent fault timing threshold ( $V_{\text{OCTRIM}}$ ), a pull-up current of 60  $\mu\text{A}$  on the TIMER pin is turned on and the GATE pin starts charging up. At a slightly higher voltage in the sense resistor, the error amplifier servos the GATE pin to maintain a constant current to the load by controlling the voltage across the sense resistor to the linear current limit,  $V_{\text{LIM}}$ .

A normal hot swap operation is complete when the board supply capacitors near full charge, and the current through the sense resistor drops to eventually reach the level of the board load current. As soon as the current drops below the overcurrent fault timing threshold, the current into the TIMER pin switches from 60  $\mu\text{A}$  pull-up to 100  $\mu\text{A}$  pull-down. The ADM1177 then drives the GATE voltage as high as it can to fully enhance the FET and reduce  $R_{\text{ON}}$  losses to a minimum.

A hot swap fails if the load current does not drop below the overcurrent fault timing threshold,  $V_{\text{OCTRIM}}$ , before the TIMER pin has charged up to 1.3 V. In this case, the GATE pin is then pulled down with a 1.5 mA to 7 mA current sink (this varies with supply voltage). The GATE pull-down stays on until a hot swap retry starts, which can be forced by deasserting and then reasserting the ON pin. On the ADM1177-1, the device retries a hot swap operation automatically after a cooldown period.

The ADM1177 also features a method of protection from sudden load current surges, such as a low impedance fault, when the current seen across the sense resistor can go well beyond the linear current limit. If the fast overcurrent trip threshold,  $V_{\text{OCFAST}}$ , is exceeded, the 1.5 mA to 7 mA GATE pull-down is turned on immediately. This pulls the GATE voltage down quickly to enable the ADM1177 to limit the length of the current spike that passes through an external FET and to bring the current through the sense resistor back into linear regulation as quickly as possible. This process protects the backplane supply from sustained overcurrent conditions that may otherwise cause the backplane supply to droop during the overcurrent event.

## CALCULATING CURRENT LIMITS AND FAULT CURRENT LIMIT TIME

The nominal linear current limit is determined by a sense resistor connected between the VCC pin and the SENSE pin, as given by Equation 1.

$$I_{\text{LIMIT(NOM)}} = V_{\text{LIM(NOM)}}/R_{\text{SENSE}} = 100 \text{ mV}/R_{\text{SENSE}} \quad (1)$$

The minimum linear fault current is given by Equation 2.

$$I_{\text{LIMIT(MIN)}} = V_{\text{LIM(MIN)}}/R_{\text{SENSE(MAX)}} = 97 \text{ mV}/R_{\text{SENSE(MAX)}} \quad (2)$$

The maximum linear fault current is given by Equation 3.

$$I_{\text{LIMIT(MAX)}} = V_{\text{LIM(MAX)}}/R_{\text{SENSE(MIN)}} = 103 \text{ mV}/R_{\text{SENSE(MIN)}} \quad (3)$$

The power rating of the sense resistor should be rated at the maximum linear fault current level.

The minimum overcurrent fault timing threshold current is given by Equation 4.

$$I_{\text{OCTRIM(MIN)}} = V_{\text{OCTRIM(MIN)}}/R_{\text{SENSE(MAX)}} = 90 \text{ mV}/R_{\text{SENSE(MAX)}} \quad (4)$$

The maximum fast overcurrent trip threshold current is given by Equation 5.

$$I_{\text{OCFAST(MAX)}} = V_{\text{OCFAST(MAX)}}/R_{\text{SENSE(MIN)}} = 115 \text{ mV}/R_{\text{SENSE(MIN)}} \quad (5)$$

The fault current limit time is the time that a device spends timing an overcurrent fault, and is given by Equation 6.

$$t_{\text{FAULT}} \approx 21.7 \times C_{\text{TIMER}} \text{ ms}/\mu\text{F} \quad (6)$$

## INITIAL TIMING CYCLE

When VCC is first connected to the backplane supply, the internal supply (Time Point 1 in Figure 32) of the ADM1177 must be charged up. A very short time later (significantly less than 1 ms), the internal supply is fully up and, because the undervoltage lockout voltage is exceeded at VCC, the device comes out of reset. During this first short reset period, the GATE pin is held down with a 25 mA pull-down current, and the TIMER pin is pulled down with a 100  $\mu\text{A}$  current sink.

The ADM1177 then goes through an initial timing cycle. At Time Point 2, the TIMER pin is pulled high with 5  $\mu\text{A}$ . At Time Point 3, the TIMER reaches the  $V_{\text{TIMERL}}$  threshold, and the first portion of the initial cycle ends. The 100  $\mu\text{A}$  current source then pulls down the TIMER pin until it reaches 0.2 V at Time Point 4. The initial cycle delay (Time Point 2 to Time Point 4) is related to  $C_{\text{TIMER}}$  as shown in Equation 7.

$$t_{\text{INITIAL}} \approx 270 \times C_{\text{TIMER}} \text{ ms}/\mu\text{F} \quad (7)$$

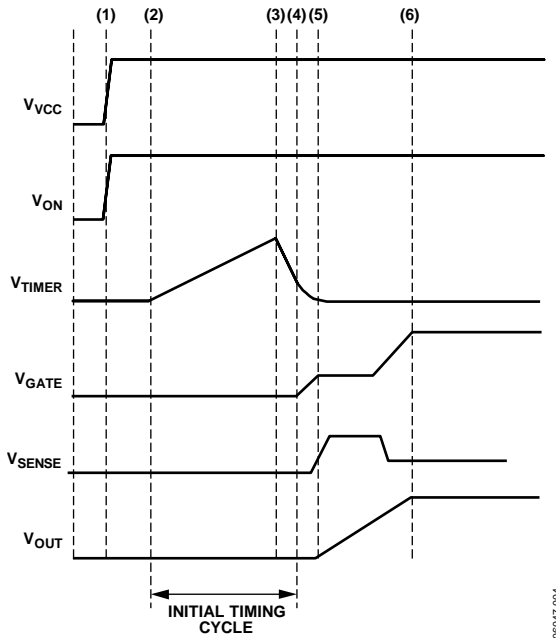

Figure 32. Startup (ON Asserts as Power Is Applied)

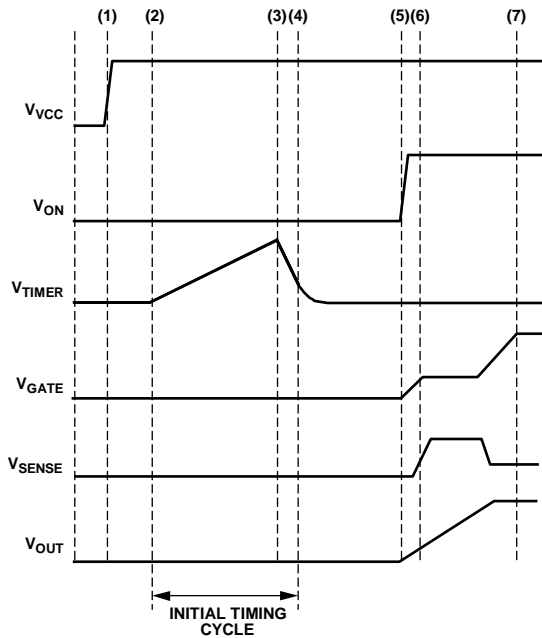

Figure 33. Startup (ON Asserts After Power Is Applied)

When the initial timing cycle terminates, the device is ready to start a hot swap operation (assuming that the ON pin is asserted). In the example shown in Figure 32, the ON pin is asserted at the same time that  $V_{CC}$  is applied; therefore, the hot swap operation starts immediately after Time Point 4. At this point, the FET gate is charged up with a  $12.5 \mu\text{A}$  current source.

At Time Point 5, the threshold voltage of the FET is reached, and the load current begins to flow. The FET is controlled to keep the sense voltage at  $100 \text{ mV}$  (this corresponds to a maximum load current level defined by the value of  $R_{\text{SENSE}}$ ).

At Time Point 6,  $V_{\text{GATE}}$  and  $V_{\text{OUT}}$  have reached their full potential, and the load current has settled to its nominal level. Figure 33 illustrates the situation where the ON pin is asserted after  $V_{CC}$  is applied.

### HOT SWAP RETRY CYCLE ON THE ADM1177-1

With the ADM1177-1, the device turns off the FET after an overcurrent fault and then uses the TIMER pin to time a delay before automatically retrying to hot swap.

As with all ADM1177 devices, an overcurrent fault is timed by charging the TIMER capacitor with a  $60 \mu\text{A}$  pull-up current. When the TIMER pin reaches  $1.3 \text{ V}$ , the fault current limit time is reached and the GATE pin is pulled down. On the ADM1177-1, the TIMER pin is then pulled down with a  $2 \mu\text{A}$  current sink. When the TIMER pin reaches  $0.2 \text{ V}$ , it automatically restarts the hot swap operation.

The cooldown period is related to  $C_{\text{TIMER}}$  by Equation 8.

$$t_{\text{COOL}} \approx 550 \times C_{\text{TIMER}} \text{ ms}/\mu\text{F} \quad (8)$$

Therefore, the retry duty cycle is as given by Equation 9.

$$t_{\text{FAULT}} / (t_{\text{COOL}} + t_{\text{FAULT}}) \times 100\% = 3.8\% \quad (9)$$

### SOFT START (SS PIN)

The SS pin is used to determine the inrush current profile. A capacitor should be attached to this pin. When the FET is requested to turn on, the SS pin is held at ground until the SENSE pin reaches a few millivolts. A current source is then turned on, which linearly ramps the capacitor up to  $1.0 \text{ V}$ . The reference voltage for the GATE linear control amplifier is derived from the soft start voltage, such that the inrush linear current limit is defined as  $I_{\text{LIMIT}} = V_{\text{SS}} / (10 \times R_{\text{SENSE}})$ .

This pin can also be driven to a voltage to alter the reference directly, thereby adjusting the current limit level with a gain of 10. See Figure 31 for an illustration of this relationship.

## VOLTAGE AND CURRENT READBACK

In addition to providing hot swap functionality, the ADM1177 also contains the components to allow voltage and current readback over an I<sup>2</sup>C bus. The voltage output of the current sense amplifier and the voltage on the VCC pin are fed into a 12-bit ADC via a multiplexer. The device can be instructed to convert voltage and/or current at any time during operation via an I<sup>2</sup>C command. When all conversions are complete, the voltage and/or current values can be read back with 12-bit accuracy in two or three bytes.

### SERIAL BUS INTERFACE

Control of the ADM1177 is carried out via the I<sup>2</sup>C bus. This interface is compatible with I<sup>2</sup>C fast mode (400 kHz maximum). The ADM1177 is connected to this bus as a slave device under the control of a master device.

### IDENTIFYING THE ADM1177 ON THE I<sup>2</sup>C BUS

The ADM1177 has a 7-bit serial bus slave address. When the device powers up, it does so with a default serial bus address. The five MSBs of the address are set to 10110; the two LSBs are determined by the state of the ADR pin. There are four different configurations available on the ADR pin that correspond to four different I<sup>2</sup>C addresses for the two LSBs (see Table 5). This scheme allows four ADM1177 devices to operate on a single I<sup>2</sup>C bus.

### GENERAL I<sup>2</sup>C TIMING

Figure 34 and Figure 35 show timing diagrams for general write and read operations using the I<sup>2</sup>C. The I<sup>2</sup>C specification defines conditions for different types of read and write operations, which are discussed in the Write and Read Operations section. The general I<sup>2</sup>C protocol operates as follows:

1. The master initiates data transfer by establishing a start condition, defined as a high-to-low transition on the serial data line, SDA, while the serial clock line, SCL, remains high. This indicates that a data stream is to follow. All slave peripherals connected to the serial bus respond to the start condition and shift in the next eight bits, consisting of a 7-bit slave address (MSB first), plus an R/W bit that determines the direction of the data transfer, that is, whether data is written to or read from the slave device (0 = write, 1 = read).

The peripheral whose address corresponds to the transmitted address responds by pulling the data line low during the low period before the ninth clock pulse, known as the acknowledge bit, and holding it low during the high period of this clock pulse. All other devices on the bus now remain idle while the selected device waits for data to be read from it or written to it. If the R/W bit is 0, the master writes to the slave device. If the R/W bit is 1, the master reads from the slave device.

2. Data is sent over the serial bus in sequences of nine clock pulses: eight bits of data followed by an acknowledge bit from the slave device. Data transitions on the data line must occur during the low period of the clock signal and remain stable during the high period, because a low-to-high transition when the clock is high can be interpreted as a stop signal.

If the operation is a write operation, the first data byte after the slave address is a command byte. This tells the slave device what to expect next. It can be an instruction, such as telling the slave device to expect a block write; or it can be a register address that tells the slave where subsequent data is to be written.

Because data can flow in only one direction, as defined by the R/W bit, it is not possible to send a command to a slave device during a read operation. Before performing a read operation, it may be necessary to first execute a write operation to tell the slave what sort of read operation to expect and/or the address from which data is to be read.

3. When all data bytes are read or written, stop conditions are established. In write mode, the master pulls the data line high during the 10<sup>th</sup> clock pulse to assert a stop condition. In read mode, the master device releases the SDA line during the SCL low period before the ninth clock pulse, but the slave device does not pull it low. This is known as a no acknowledge. The master then takes the data line low during the SCL low period before the 10<sup>th</sup> clock pulse, then high during the 10<sup>th</sup> clock pulse to assert a stop condition.

Table 5. Setting I<sup>2</sup>C Addresses via the ADR Pin

| Base Address | ADR Pin State      | ADR Pin Logic State | Address in Binary <sup>1</sup> | Address in Hex |
|--------------|--------------------|---------------------|--------------------------------|----------------|
| 10110        | Ground             | 00                  | 1011000X                       | 0xB0           |
|              | Resistor to ground | 01                  | 1011001X                       | 0xB2           |
|              | Floating           | 10                  | 1011010X                       | 0xB4           |
|              | High               | 11                  | 1011011X                       | 0xB6           |

<sup>1</sup> X = don't care.

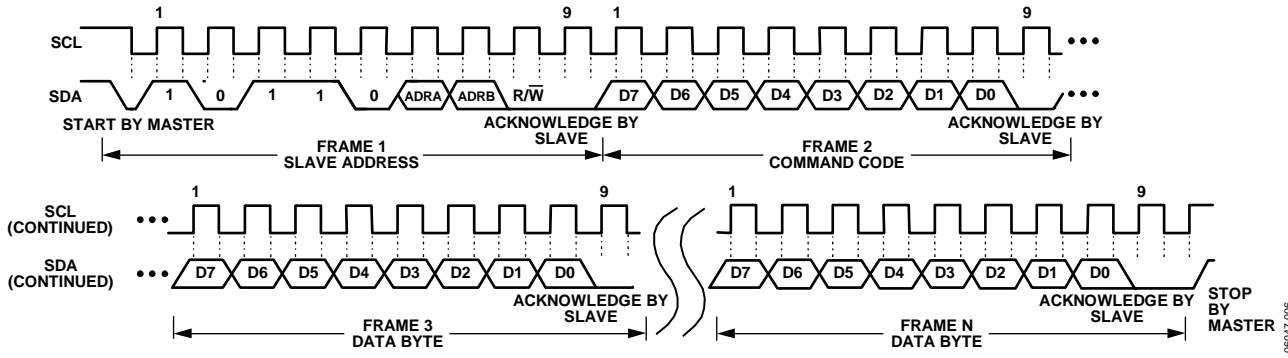

Figure 34. General I2C Write Timing Diagram

06047-006

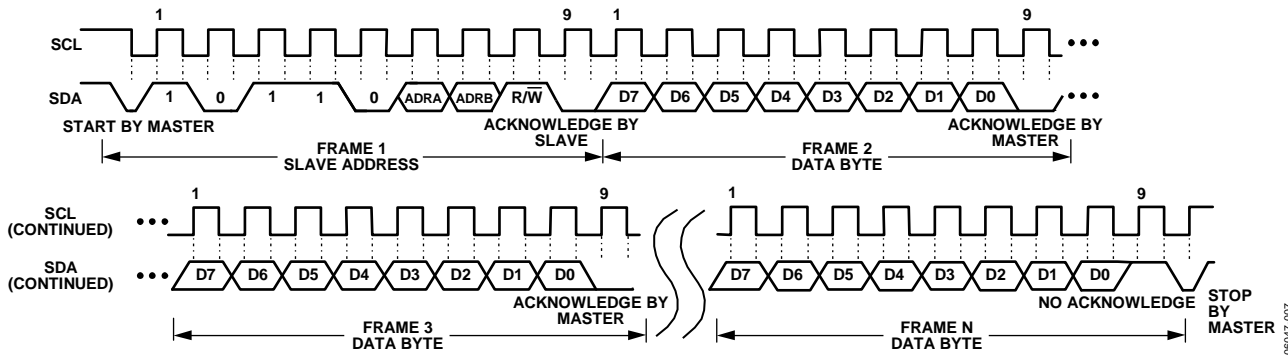

Figure 35. General I2C Read Timing Diagram

06047-007

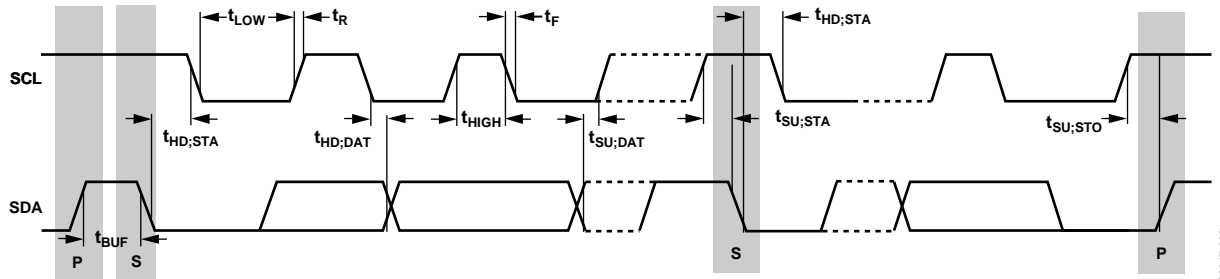

Figure 36. Serial Bus Timing Diagram

06047-008



## WRITE AND READ OPERATIONS

The I<sup>2</sup>C specification defines several protocols for different types of read and write operations. The operations used in the ADM1177 are discussed in this section. Table 6 shows the abbreviations used in the command diagrams (see Figure 37 to Figure 42).

**Table 6. I<sup>2</sup>C Abbreviations**

| Abbreviation | Condition      |
|--------------|----------------|
| S            | Start          |
| P            | Stop           |
| R            | Read           |
| W            | Write          |
| A            | Acknowledge    |
| N            | No acknowledge |

### QUICK COMMAND

The quick command operation allows the master to check if the slave is present on the bus, as follows:

1. The master device asserts a start condition on SDA.
2. The master sends the 7-bit slave address, followed by the write bit (low).
3. The addressed slave device asserts an acknowledge on SDA.
4. The master asserts a stop condition on SDA to end the transaction.

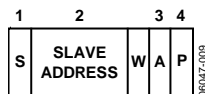

Figure 37. Quick Command

### WRITE COMMAND BYTE

In the write command byte operation, the master device sends a command byte to the slave device, as follows:

1. The master device asserts a start condition on SDA.
2. The master sends the 7-bit slave address, followed by the write bit (low).
3. The addressed slave device asserts an acknowledge on SDA.
4. The master sends the command byte. The command byte is identified by an MSB = 0. An MSB = 1 indicates an extended register write (see the Write Extended Command Byte section).
5. The slave asserts an acknowledge on SDA.
6. The master asserts a stop condition on SDA to end the transaction.

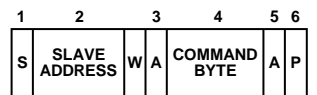

Figure 38. Write Command Byte

The seven LSBs of the command byte are used to configure and control the ADM1177. Table 7 provides details of the function of each bit.

**Table 7. Command Byte Operations**

| Bit | Default | Name      | Function  |
|-----|---------|-----------|---|
| C0  | 0       | V_CONT    | LSB, set to convert voltage continuously. If readback is attempted before the first conversion is complete, the ADM1177 asserts an acknowledge and returns all 0s in the returned data.   |
| C1  | 0       | V_ONCE    | Set to convert voltage once. Self-clears. I <sup>2</sup> C asserts a no acknowledge on attempted reads until the ADC conversion is complete.  |
| C2  | 0       | I_CONT    | Set to convert current continuously. If readback is attempted before the first conversion is complete, the ADM1177 asserts an acknowledge and returns all 0s in the returned data.  |
| C3  | 0       | I_ONCE    | Set to convert current once. Self-clears. I <sup>2</sup> C asserts a no acknowledge on attempted reads until the ADC conversion is complete.  |
| C4  | 0       | VRANGE    | Selects different internal attenuation resistor networks for voltage readback. A 0 in C4 selects a 14:1 voltage divider. A 1 in C4 selects a 7:2 voltage divider. With an ADC full scale of 1.902 V, the voltage at the VCC pin for an ADC full-scale result is 26.35 V for VRANGE = 0 and 6.65 V for VRANGE = 1. |
| C5  | 0       | N/A       | Unused.   |
| C6  | 0       | STATUS_RD | Status read. When this bit is set, the data byte read back from the ADM1177 is the status byte. It contains the status of the device alerts. See Table 15 for full details of the status byte.  |

## WRITE EXTENDED COMMAND BYTE

In the write extended command byte operation, the master device writes to one of the three extended registers of the slave device, as follows:

1. The master device asserts a start condition on SDA.
2. The master sends the 7-bit slave address, followed by the write bit (low).
3. The addressed slave device asserts an acknowledge on SDA.
4. The master sends the register address byte. The MSB of this byte is set to 1 to indicate an extended register write. The two LSBs indicate which of the three extended registers is to be written to (see Table 8). All other bits should be set to 0.
5. The slave asserts an acknowledge on SDA.
6. The master sends the extended command byte (see Table 9, Table 10, and Table 11).

7. The slave asserts an acknowledge on SDA.
8. The master asserts a stop condition on SDA to end the transaction.



Figure 39. Write Extended Byte

Table 9, Table 10, and Table 11 provide the details of each extended register.

Table 8. Extended Register Addresses

| A6 | A5 | A4 | A3 | A2 | A1 | A0 | Extended Register |
|----|----|----|----|----|----|----|-------------------|
| 0  | 0  | 0  | 0  | 0  | 0  | 1  | ALERT_EN          |
| 0  | 0  | 0  | 0  | 0  | 1  | 0  | ALERT_TH          |
| 0  | 0  | 0  | 0  | 0  | 1  | 1  | CONTROL           |

Table 9. ALERT\_EN Register Operations

| Bit | Default | Name         | Function   |
|-----|---------|--------------|--|
| 0   | 0       | EN_ADC_OC1   | LSB, enabled if a single ADC conversion on the I channel exceeds the threshold set in the ALERT_TH register.   |
| 1   | 0       | EN_ADC_OC4   | Enabled if four consecutive ADC conversions on the I channel exceed the threshold set in the ALERT_TH register.  |
| 2   | 1       | EN_HS_ALERT  | Enabled if the hot swap operation either latches off or enters a cooldown cycle because of an overcurrent event.   |
| 3   | 0       | EN_OFF_ALERT | Enables an alert if the hot swap operation is turned off by a transition that deasserts the ON pin or by an operation that writes the SWOFF bit high.  |
| 4   | 0       | CLEAR        | Clears the OFF_ALERT, HS_ALERT, and ADC_ALERT status bits in the STATUS register. The value of these bits may immediately change if the source of the alert is not cleared and the alert function is not disabled. This CLEAR bit self-clears to 0 after the STATUS register bits are cleared. |

Table 10. ALERT\_TH Register Operations

| Bit   | Default | Function   |
|-------|---------|--|
| [7:0] | FF      | The ALERT_TH register sets the current level at which an alert occurs. Defaults to ADC full scale. The ALERT_TH 8-bit value corresponds to the top eight bits of the current channel data. |

Table 11. CONTROL Register Operations

| Bit | Default | Name  | Function  |
|-----|---------|-------|---|
| 0   | 0       | SWOFF | LSB, forces the hot swap operation off. Equivalent to deasserting the ON pin. |

### READ VOLTAGE AND/OR CURRENT DATA BYTES

Depending on how the device is configured, the ADM1177 can be set up to provide information in three ways: voltage and current readback, voltage only readback, and current only readback. See the Write Command Byte section for more details.

#### Voltage and Current Readback

The ADM1177 digitizes both voltage and current. Three bytes are read back in the format shown in Table 12.

Table 12. Voltage and Current Readback Format

| Byte | Contents     | B7  | B6  | B5 | B4 | B3 | B2 | B1 | B0 |
|------|--------------|-----|-----|----|----|----|----|----|----|
| 1    | Voltage MSBs | V11 | V10 | V9 | V8 | V7 | V6 | V5 | V4 |
| 2    | Current MSBs | I11 | I10 | I9 | I8 | I7 | I6 | I5 | I4 |
| 3    | LSBs         | V3  | V2  | V1 | V0 | I3 | I2 | I1 | I0 |

#### Voltage Readback

The ADM1177 digitizes voltage only. Two bytes are read back in the format shown in Table 13.

Table 13. Voltage Only Readback Format

| Byte | Contents     | B7  | B6  | B5 | B4 | B3 | B2 | B1 | B0 |
|------|--------------|-----|-----|----|----|----|----|----|----|
| 1    | Voltage MSBs | V11 | V10 | V9 | V8 | V7 | V6 | V5 | V4 |
| 2    | Voltage LSBs | V3  | V2  | V1 | V0 | 0  | 0  | 0  | 0  |

#### Current Readback

The ADM1177 digitizes current only. Two bytes are read back in the format shown in Table 14.

Table 14. Current Only Readback Format

| Byte | Contents     | B7  | B6  | B5 | B4 | B3 | B2 | B1 | B0 |
|------|--------------|-----|-----|----|----|----|----|----|----|
| 1    | Current MSBs | I11 | I10 | I9 | I8 | I7 | I6 | I5 | I4 |
| 2    | Current LSBs | I3  | I2  | I1 | I0 | 0  | 0  | 0  | 0  |

The following series of events occurs when the master receives three bytes (voltage and current data) from the slave device:

1. The master device asserts a start condition on SDA.
2. The master sends the 7-bit slave address, followed by the read bit (high).
3. The addressed slave device asserts an acknowledge on SDA.
4. The master receives the first data byte.
5. The master asserts an acknowledge on SDA.
6. The master receives the second data byte.
7. The master asserts an acknowledge on SDA.
8. The master receives the third data byte.
9. The master asserts a no acknowledge on SDA.
10. The master asserts a stop condition on SDA, and the transaction ends.

For cases where the master is reading voltage only or current only, only two data bytes are read and Step 7 and Step 8 are not required.

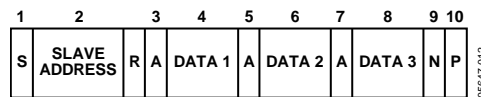

Figure 40. Three-Byte Read from ADM1177

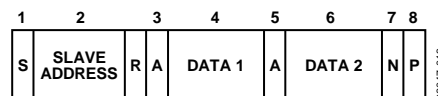

Figure 41. Two-Byte Read from ADM1177

### Converting ADC Codes to Voltage and Current Readings

The following equations can be used to convert ADC codes representing voltage and current from the ADM1177 12-bit ADC into actual voltage and current values.

$$Voltage = (V_{FULLSCALE}/4096) \times Code \tag{10}$$

where:

$$V_{FULLSCALE} = 6.65 \text{ V (7:2 range) or } 26.35 \text{ V (14:1 range).}$$

Code is the ADC voltage code read from the device (Bit V11 to Bit V0).

$$Current = ((I_{FULLSCALE}/4096) \times Code)/Sense \text{ Resistor} \tag{11}$$

where:

$$I_{FULLSCALE} = 105.84 \text{ mV.}$$

Code is the ADC current code read from the device (Bit I11 to Bit I0).

### Read Status Register

A single register of status data can also be read from the ADM1177 as follows:

1. The master device asserts a start condition on SDA.
2. The master sends the 7-bit slave address followed by the read bit (high).
3. The addressed slave device asserts an acknowledge on SDA.
4. The master receives the status byte.
5. The master asserts an acknowledge on SDA.

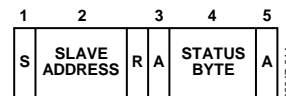

Figure 42. Status Read from ADM1177

Table 15 shows the ADM1177 STATUS registers in detail. Note that Bit 1, Bit 3, and Bit 5 are cleared by writing to Bit 4 (the CLEAR bit) of the ALERT\_EN register

**Table 15. Status Byte Operations**

| Bit | Name       | Function   |
|-----|------------|--|
| 0   | ADC_OC     | An ADC-based overcurrent comparison is detected on the last three conversions  |
| 1   | ADC_ALERT  | An ADC-based overcurrent trip has occurred, causing the alert. Cleared by writing to Bit 4 of the ALERT_EN register.   |
| 2   | HS_OC      | The hot swap operation is off due to an analog overcurrent event. On parts that latch off, this is the same as the HS_ALERT status bit (if EN_HS_ALERT = 1). On the retry parts, this indicates the current state: a 0 can indicate that the data was read during a period when the device was retrying, or that it has successfully hot swapped by retrying after at least one overcurrent timeout. |
| 3   | HS_ALERT   | The hot swap operation has failed since the last time this was reset. Cleared by writing to Bit 4 of the ALERT_EN register.  |
| 4   | OFF_STATUS | The state of the ON pin. Set to 1 if the input pin is deasserted. Can also be set to 1 by writing to the SWOFF bit of the CONTROL register.  |
| 5   | OFF_ALERT  | An alert has been caused by either the ON pin or the SWOFF bit. Cleared by writing to Bit 4 of the ALERT_EN register.  |

# APPLICATIONS INFORMATION

## APPLICATIONS WAVEFORMS

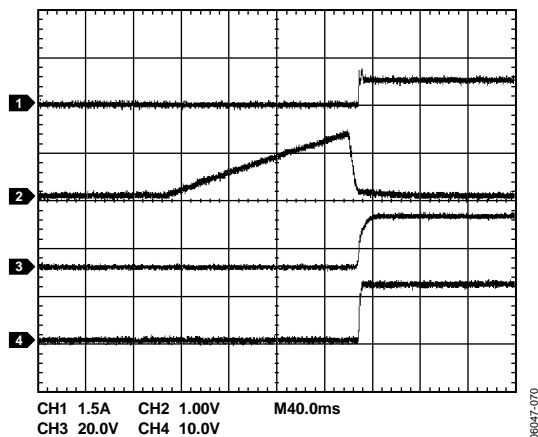

Figure 43. Inrush Current Control into 220  $\mu$ F Load  
(Channel 1 =  $I_{LOAD}$ , Channel 2 =  $V_{TIMER}$ , Channel 3 =  $V_{GATE}$ , Channel 4 =  $V_{OUT}$ )

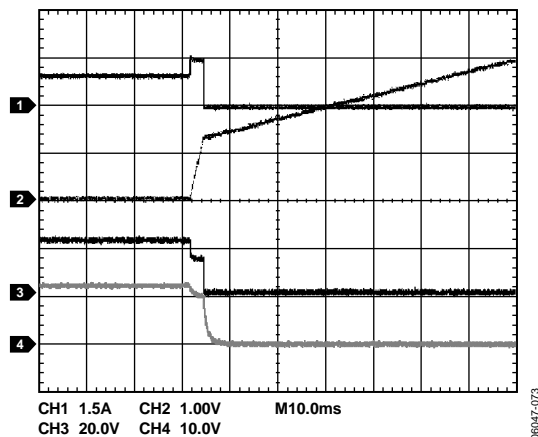

Figure 46. Overcurrent Condition During Operation (ADM1177-1 Model)  
(Channel 1 =  $I_{LOAD}$ , Channel 2 =  $V_{TIMER}$ , Channel 3 =  $V_{GATE}$ , Channel 4 =  $V_{OUT}$ )

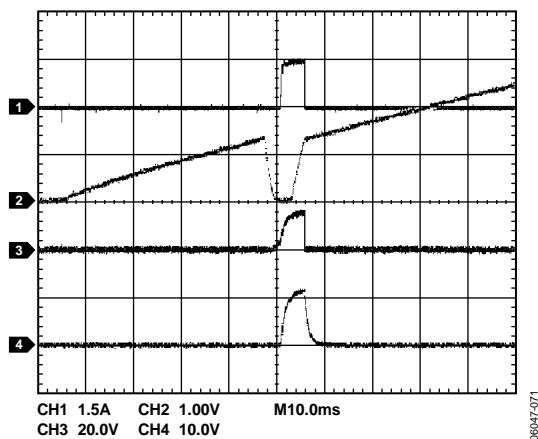

Figure 44. Overcurrent Condition at Startup (ADM1177-1 Model)  
(Channel 1 =  $I_{LOAD}$ , Channel 2 =  $V_{TIMER}$ , Channel 3 =  $V_{GATE}$ , Channel 4 =  $V_{OUT}$ )

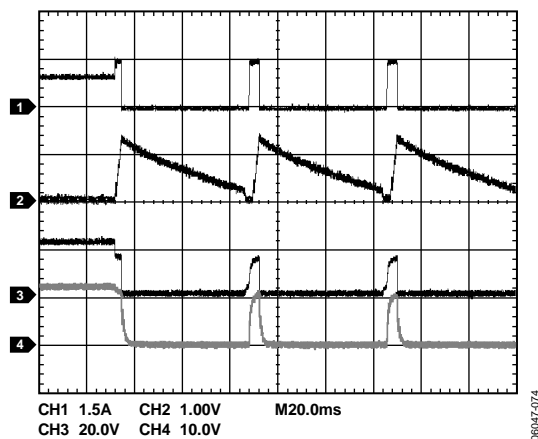

Figure 47. Overcurrent Condition During Operation (ADM1177-2 Model)  
(Channel 1 =  $I_{LOAD}$ , Channel 2 =  $V_{TIMER}$ , Channel 3 =  $V_{GATE}$ , Channel 4 =  $V_{OUT}$ )

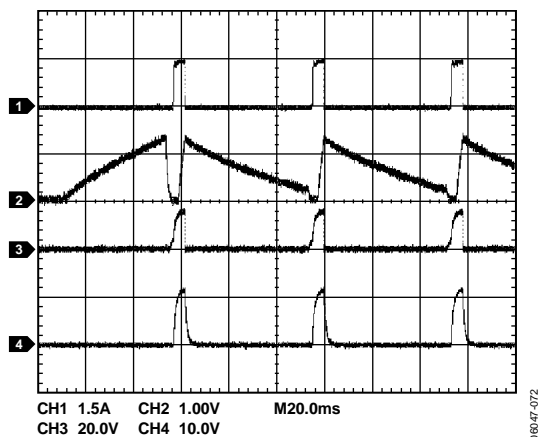

Figure 45. Overcurrent Condition at Startup (ADM1177-2 Model)  
(Channel 1 =  $I_{LOAD}$ , Channel 2 =  $V_{TIMER}$ , Channel 3 =  $V_{GATE}$ , Channel 4 =  $V_{OUT}$ )

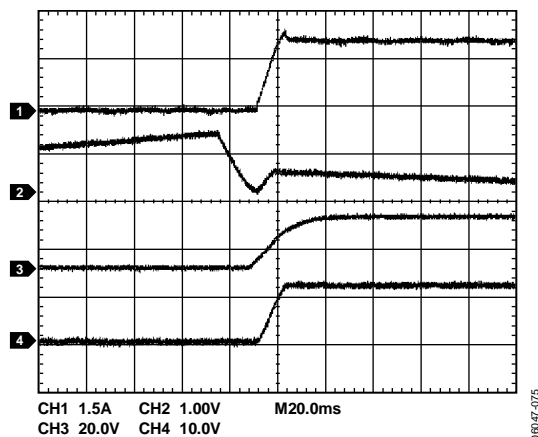

Figure 48. Inrush Current Control with Profiling of Initial Current Edge via a Capacitor on the SS Pin  
(Channel 1 =  $I_{LOAD}$ , Channel 2 =  $V_{TIMER}$ , Channel 3 =  $V_{GATE}$ , Channel 4 =  $V_{OUT}$ )

## KELVIN SENSE RESISTOR CONNECTION

When using a low value sense resistor for high current measurement, the problem of parasitic series resistance may arise. The lead resistance can be a substantial fraction of the rated resistance, making the total resistance a function of lead length. This problem can be avoided by using a Kelvin sense connection. This type of connection separates the current path through the resistor and the voltage drop across the resistor. Figure 49 shows the correct way to connect the sense resistor between the VCC pin and the SENSE pin of the ADM1177.

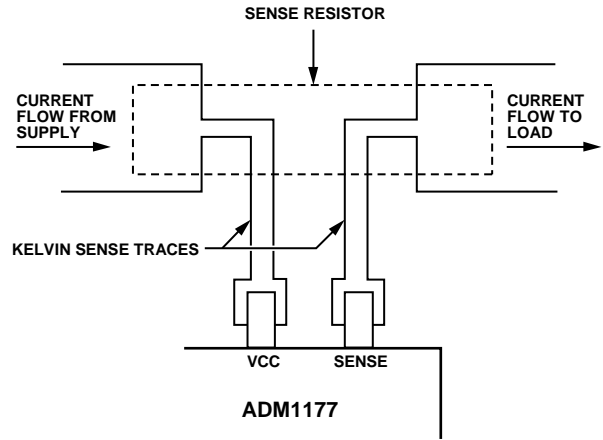
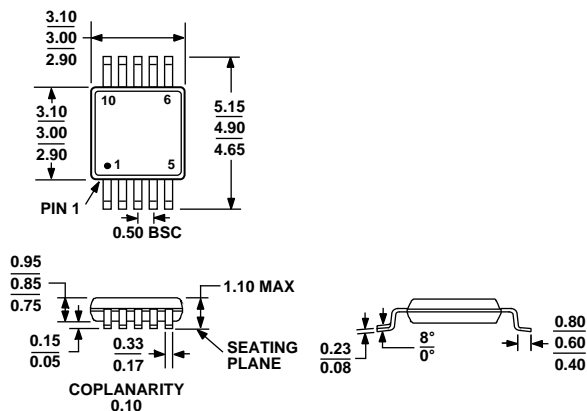

Figure 49. Kelvin Sense Connections

06047-015

## OUTLINE DIMENSIONS



COMPLIANT TO JEDEC STANDARDS MO-187-BA

Figure 50. 10-Lead Mini Small Outline Package [MSOP] (RM-10)

Dimensions shown in millimeters

## ORDERING GUIDE

| Model                         | Hot Swap Retry Option   | Temperature Range | Package Description | Package Option | Branding |
|-------------------------------|-------------------------|-------------------|---------------------|----------------|----------|
| ADM1177-1ARMZ-R7 <sup>1</sup> | Automatic Retry Version | -40°C to +85°C    | 10-Lead MSOP        | RM-10          | M5Y      |
| ADM1177-2ARMZ-R7 <sup>1</sup> | Latched Off Version     | -40°C to +85°C    | 10-Lead MSOP        | RM-10          | M5Z      |
| EVAL-ADM1177EBZ <sup>1</sup>  |                         |                   | Evaluation Board    |                |          |

<sup>1</sup> Z = RoHS Compliant Part.

**NOTES**

Purchase of licensed I<sup>2</sup>C components of Analog Devices, Inc., or one of its sublicensed Associated Companies conveys a license for the purchaser under the Philips I<sup>2</sup>C Patent Rights to use these components in an I<sup>2</sup>C system, provided that the system conforms to the I<sup>2</sup>C Standard Specification as defined by Philips.